

DIMENSIONAL DATA

Axolute AIR cover plates and support frames

AXOLUTE AIR COVER PLATES

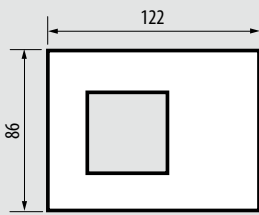

HW4802...

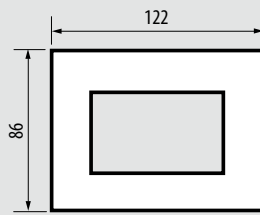

HW4803...

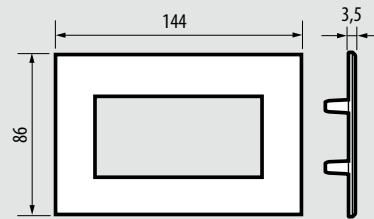

HW4804...

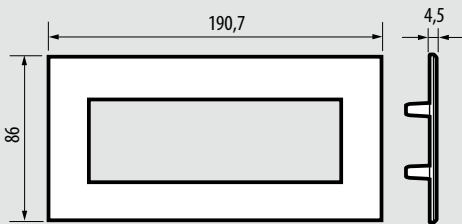

HW4806...

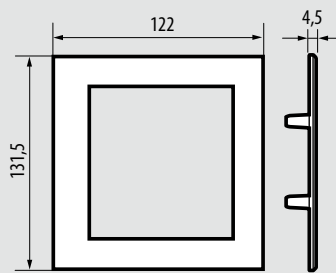

HW4826...

AXOLUTE AIR SUPPORT FRAMES

2 AND 3 MODULES

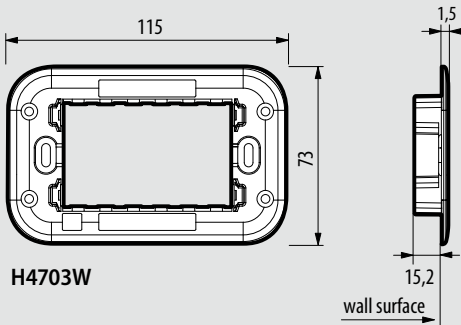

H4703W

4 MODULES

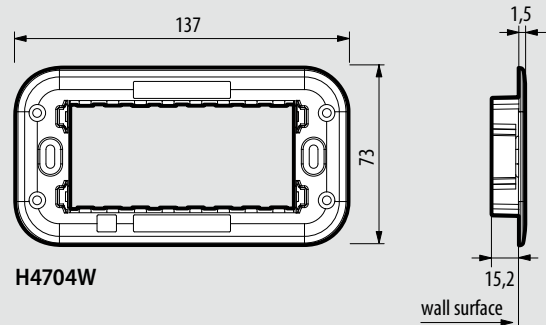

H4704W

6 MODULES

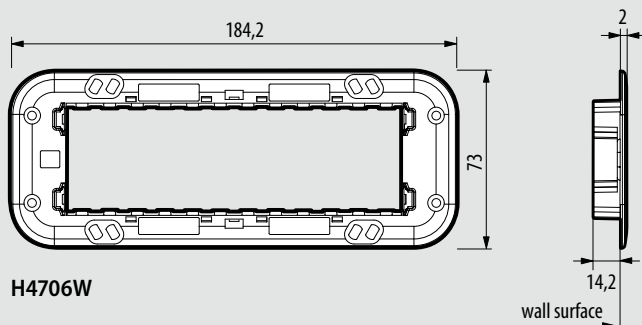

H4706W

3+3 MODULES

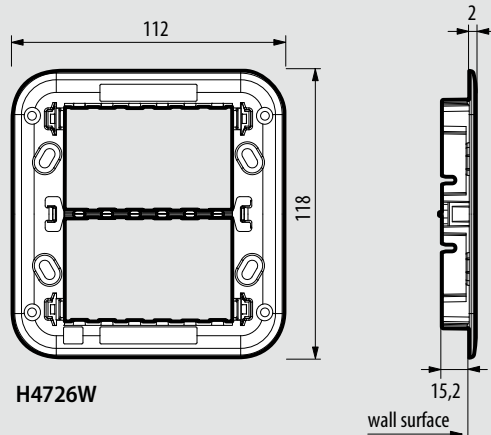

H4726W

DIMENSIONAL DATA

Rectangular cover plates

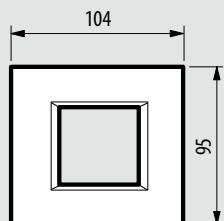

HA4802...

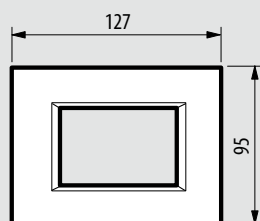

HA4803... - HC4657M3
HA4829... - HS4657M3

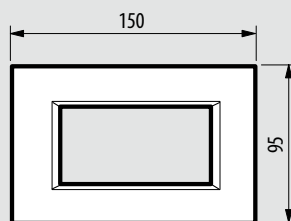

HA4804... - HC4657M4
- HS4657M4

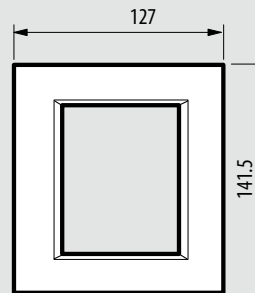

HA4826...

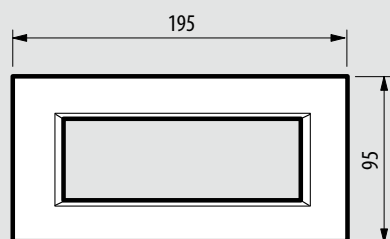

HA4806...
HA4830...

CENTRE DISTANCE 71 mm - HORIZONTAL

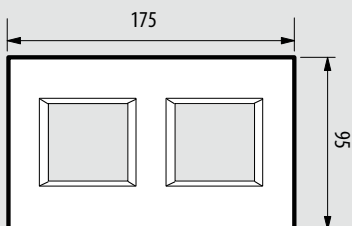

HA4802M2H...

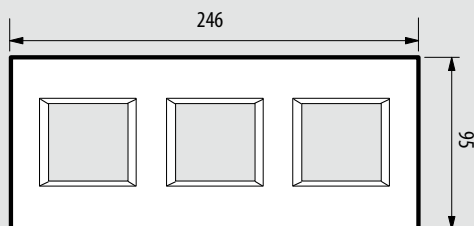

HA4802M3H...

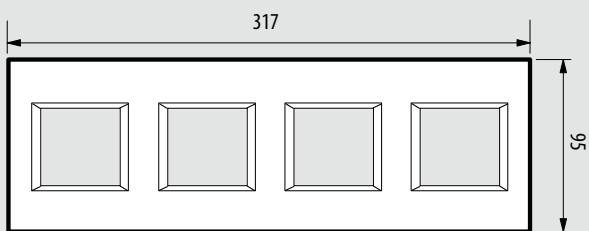

HA4802M4H...

DIMENSIONAL DATA
 Elliptic cover plates

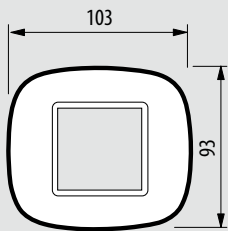

HB4802...

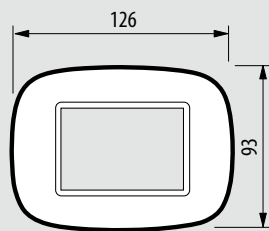

HB4803...

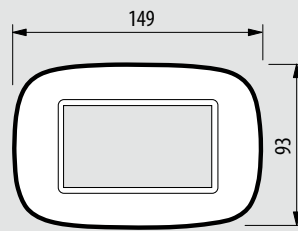

HB4804...

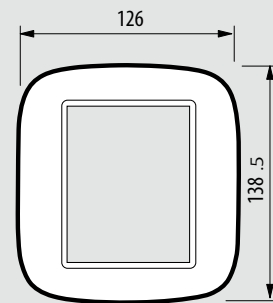

HB4826...

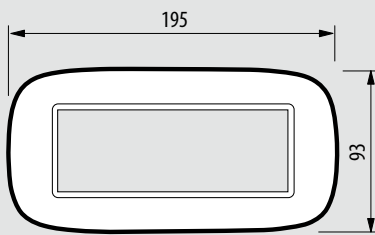

HB4806...

CENTRE DISTANCE 71 mm - HORIZONTAL/VERTICAL

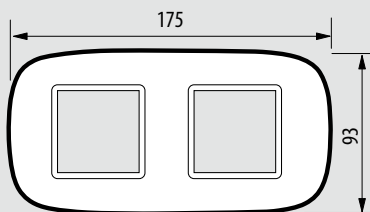

HB4802/2... - HB4802M2...

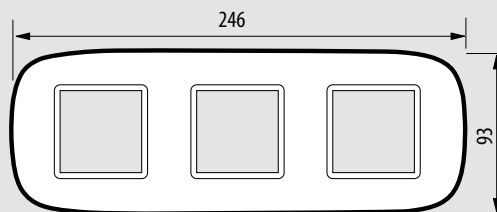

HB4802/3... - HB4802M3...

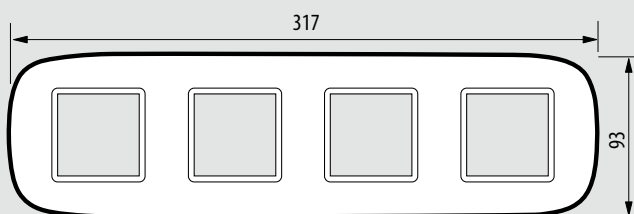

HB4802/4... - HB4802M4...

DIMENSIONAL DATA

Supporting frames - Devices

MAIN SUPPORTING FRAMES

2 MODULES

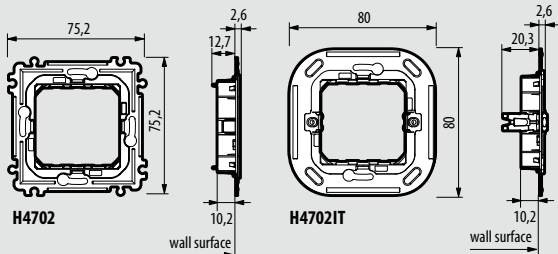

3 MODULES

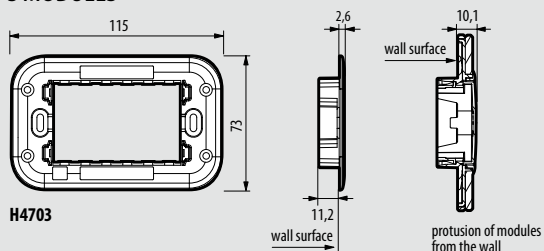

4 MODULES

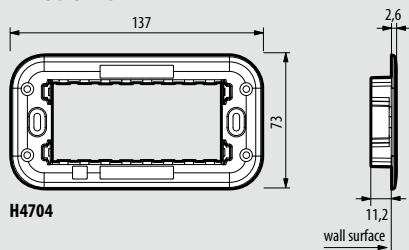

6 MODULES

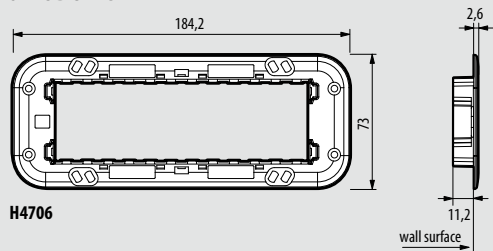

3+3 MODULES

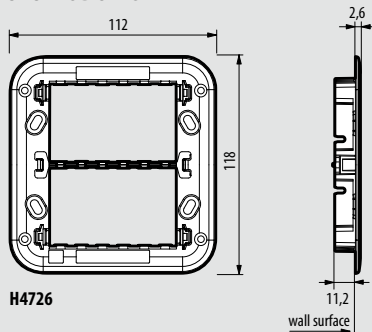

MODULAR DEVICES

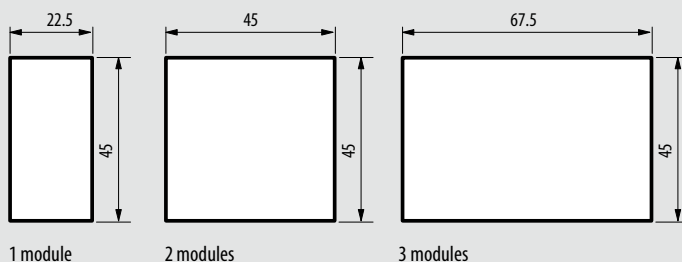

DIN DEVICES

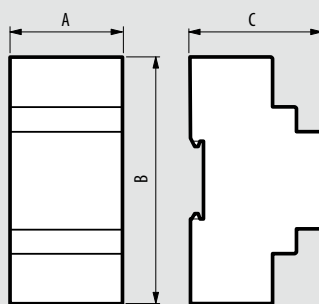

DIN dimension chart (mm)

No. of Modules	A	B	C
1	17.5	90	60/61
2	35		
3	52.5		
4	70		
5	87.5		
6	105		
7	122.5		
8	140		
9	157.5		
10	175		

NON MODULAR DEVICES

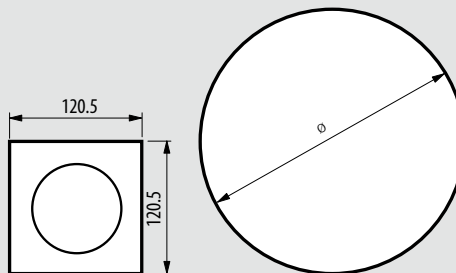

HD-HC-HS4565
HD-HC-HS4070

L4566 - Ø240
L4566/10 - Ø100

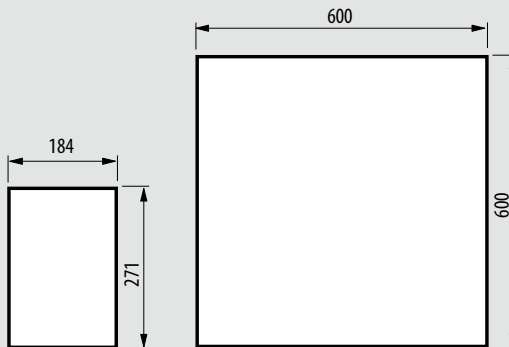

L4567

L4568