

GERMAN AND FRENCH STANDARD ASSEMBLY

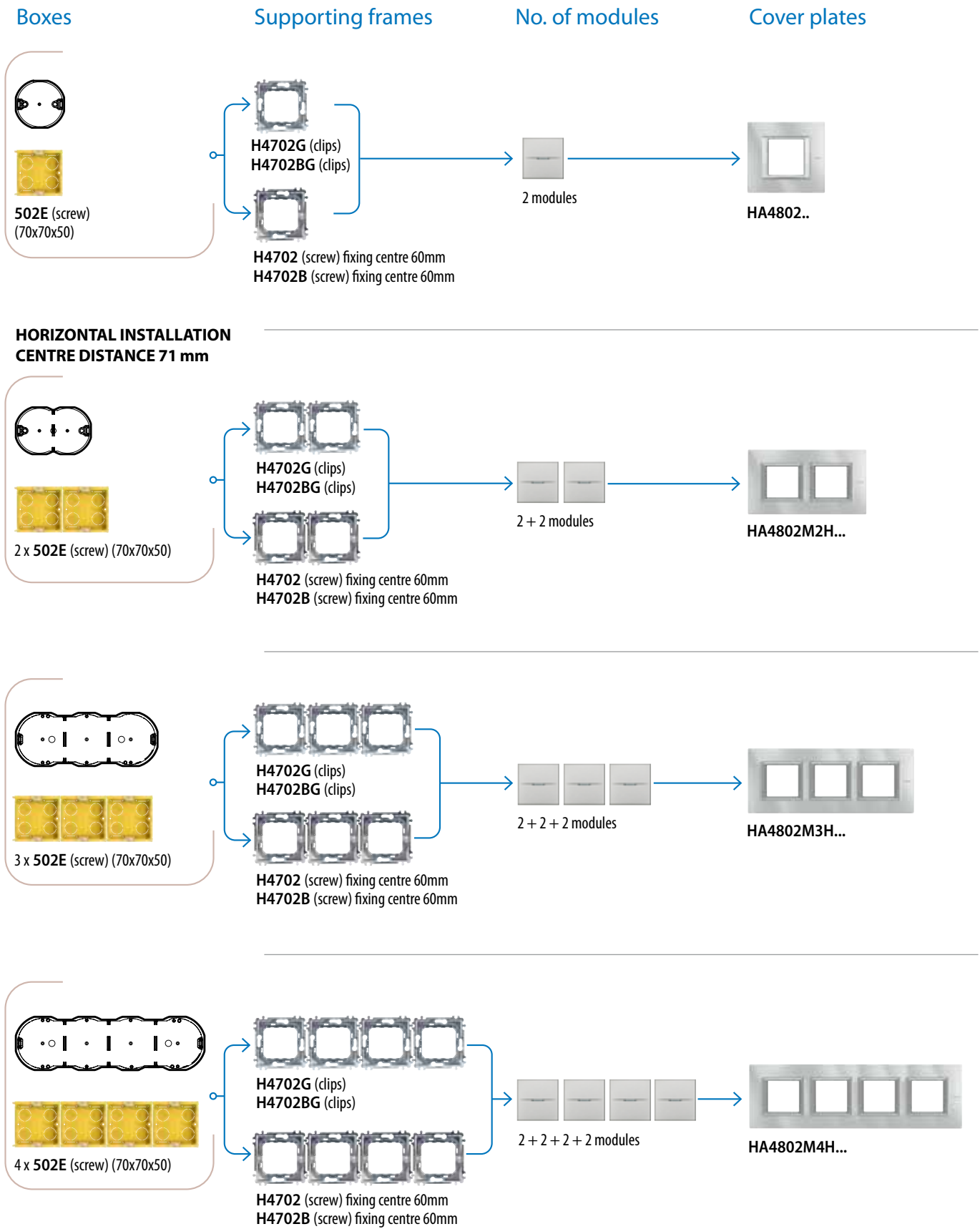

NOTE: the supporting frames are supplied with a transparent protection.
 Devices available in white, tech and atracite colour.

GERMAN AND FRENCH STANDARD RECTANGULAR COVER PLATES: TABLE FOR SELECTING CODES

MODULES				
HORIZONTAL				
2	2+2	2+2+2	2+2+2+2	
centre distance 71mm	centre distance 71mm	centre distance 71mm	centre distance 71mm	

RECTANGULAR COVER PLATES

MONOCHROME					
	AXOLUTE white	HA4802HD	HA4802M2HHD	HA4802M3HHD	HA4802M4HHD
	Tech	HA4802HC	HA4802M2HHC	HA4802M3HHC	HA4802M4HHC
	Anthracite	HA4802HS	HA4802M2HHS	HA4802M3HHS	HA4802M4HHS
METALLIZED					
	brushed aluminium	HA4802XC	HA4802M2HXC	HA4802M3HXC	HA4802M4HXC
	brushed anthracite	HA4802XS	HA4802M2HXS	HA4802M3HXS	HA4802M4HXS
	brushed titanium	HA4802NX	HA4802M2HNX	HA4802M3HNX	HA4802M4HNX
LACQUERED					
	white Limoges	HA4802BG	HA4802M2HBG	HA4802M3HBG	HA4802M4HBG
ANODIZED					
	brushed chrome	HA4802CR	HA4802M2HCR	HA4802M3HCR	HA4802M4HCR
	brushed bronze	HA4802BR	HA4802M2HBR	HA4802M3HBR	HA4802M4HBR
	silver mat	HA4802SAN	HA4802M2HSAN	HA4802M3HSAN	HA4802M4HSAN
GLASS					
	black glass	HA4802VNN	HA4802M2HVNN	HA4802M3HVNN	HA4802M4HVNN
	kristall glass	HA4802VKA	HA4802M2HVKA	HA4802M3HVKA	HA4802M4HVKA
	mirror glass	HA4802VSA	HA4802M2HVSA	HA4802M3HVSA	HA4802M4HVSA
	white glass	HA4802VBB	HA4802M2HVBB	HA4802M3HVBB	HA4802M4HVBB

SUPPORTING FRAMES

fixing with screws	H4702	H4702 (x2)	H4702 (x3)	H4702 (x4)	H4732/2	H4732/3
with clips	H4702G	H4702G (x2)	H4702G (x3)	H4702G (x4)	H4732/2G	H4732/3G
luminous supporting frames (with screws) for rectangular cover plates	HA4702X					

BRITISH STANDARD ASSEMBLY

Boxes

Supporting frames

No. of modules

Cover plates

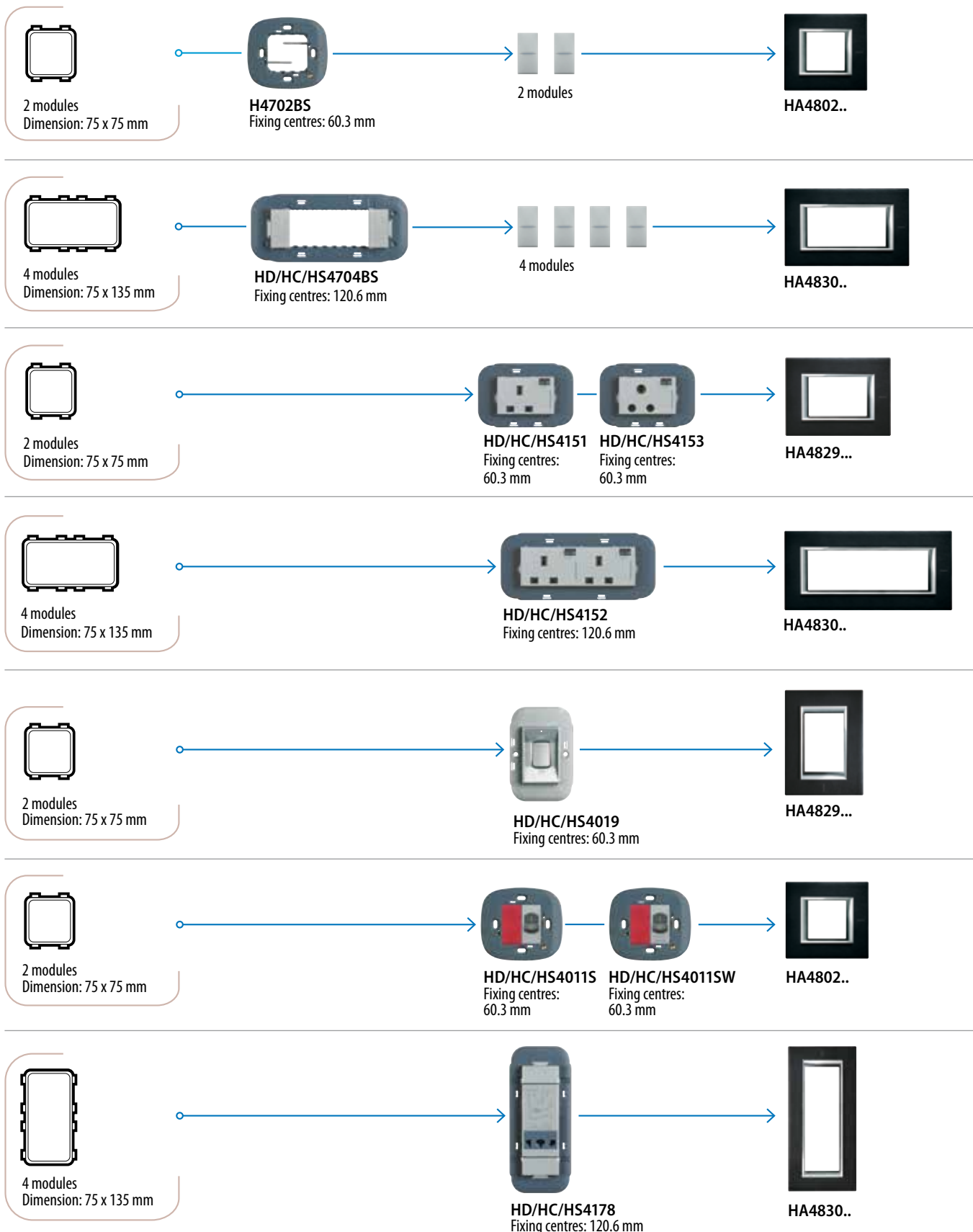

NOTE: before installing boxes, check plate dimensions (see pages Dimensional data)
Devices available in white, tech and atracite colour.

BRITISH STANDARD RECTANGULAR COVER PLATES: TABLE FOR SELECTING CODES

MODULES		SWITCH SOCKETS		45 A SWITCHES	32A SWITCHES	"SHAVER SUPPLY UNIT"
2	4	1 gang HD-HC-HS4151 HD-HC-HS4153	2 gang HD-HC-HS4152	HD-HC-HS4019	HD-HC-HS4011S HD-HC-HS4011SW	HD-HC-HS4178

RECTANGULAR COVER PLATES

MONOCHROME								
	AXOLUTE white	HA4802HD	HA4830HD	HA4829HD	HA4830HD	HA4829HD	HA4802HD	HA4830HD
	Tech	HA4802HC	HA4830HC	HA4829HC	HA4830HC	HA4829HC	HA4802HC	HA4830HC
	Anthracite	HA4802HS	HA4830HS	HA4829HS	HA4830HS	HA4829HS	HA4802HS	HA4830HS
ALUMINIUM								
	brushed aluminium	HA4802XC	HA4830XC	HA4829XC	HA4830XC	HA4829XC	HA4802XC	HA4830XC
	brushed anthracite	HA4802XS	HA4830XS	HA4829XS	HA4830XS	HA4829XS	HA4802XS	HA4830XS
	brushed titanium	HA4802NX	HA4830NX	HA4829NX	HA4830NX	HA4829NX	HA4802NX	HA4830NX
LACQUERED								
	white Limoges	HA4802BG	HA4802M2HBG	HA4802M3HBG	HA4802M4HBG	HA4832/2BG	HA4832/3BG	
ANODIZED								
	brushed chrome	HA4802CR	HA4830CR	HA4829CR	HA4830CR	HA4829CR	HA4802CR	HA4830CR
	brushed bronze	HA4802BR	HA4830BR	HA4829BR	HA4830BR	HA4829BR	HA4802BR	HA4830BR
	brushed mercury	HA4802AZ	HA4830AZ	HA4829AZ	HA4830AZ	HA4829AZ	HA4802AZ	HA4830AZ
	silver mat	HA4802SAN	HA4830SAN	HA4829SAN	HA4830SAN	HA4829SAN	HA4802SAN	HA4830SAN
GLASS								
	black glass	HA4802VNN	HA4830VNN	HA4829VNN	HA4830VNN	HA4829VNN	HA4802VNN	HA4830VNN
	kristall glass	HA4802VKA	HA4830VKA	HA4829VKA	HA4830VKA	HA4829VKA	HA4802VKA	HA4830VKA
	mirror glass	HA4802VSA	HA4830VSA	HA4829VSA	HA4830VSA	HA4829VSA	HA4802VSA	HA4830VSA
	white glass	HA4802VBB	HA4830VBB	HA4829VBB	HA4830VBB	HA4829VBB	HA4802VBB	HA4830VBB

SUPPORTING FRAMES

fixing with screws	H4702BS
with white screw caps	HD4704BS
with aluminium screw caps	HC4704BS
with anthracite screw caps	HS4704BS
luminous supporting frames (with screws)	HA4702X
for rectangular cover plates	
Items conform to BS 5733	

AMERICAN STANDARD ASSEMBLY

Boxes

Supporting frames

No. of modules

Cover plates

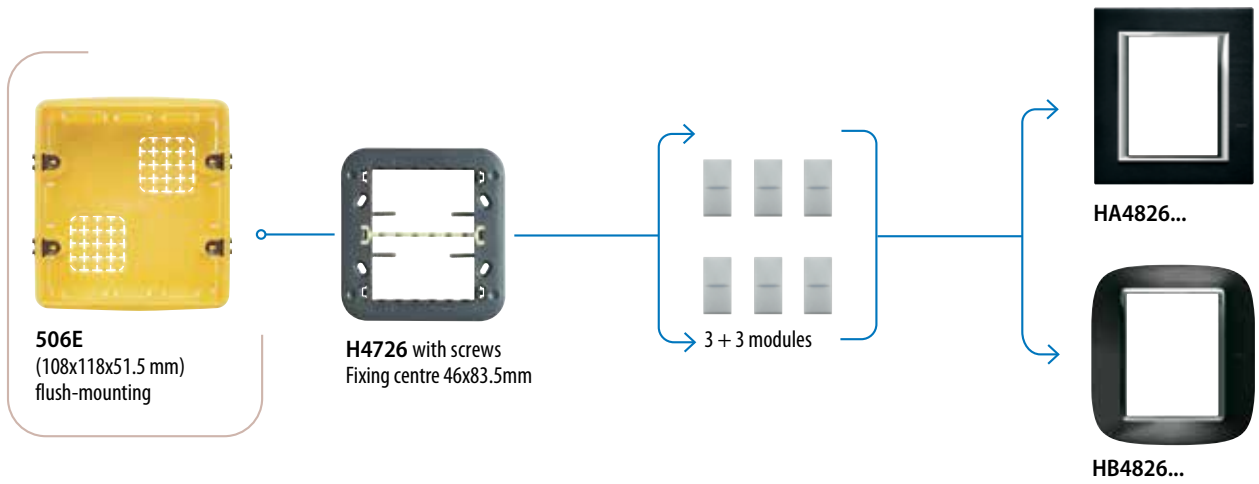
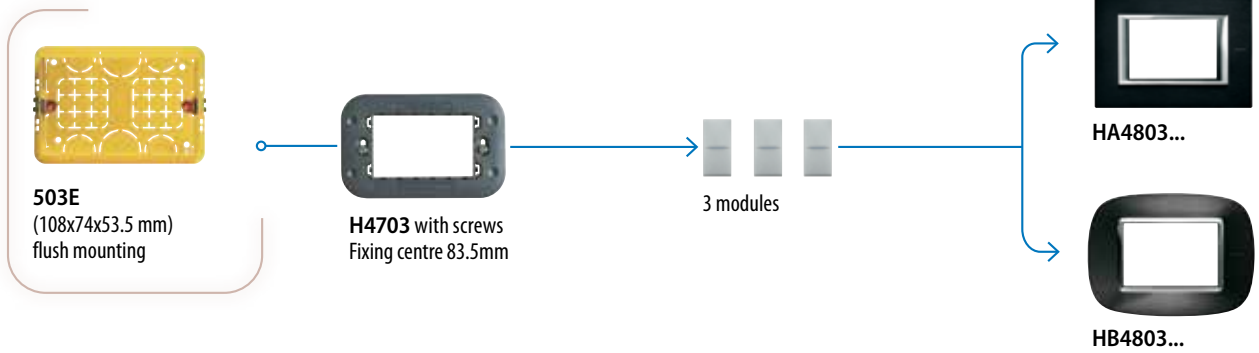

NOTE: devices available in white, tech and athracite colour.

AMERICAN STANDARD COVER PLATES: TABLE FOR SELECTING CODES

MODULES	
3	3+3

RECTANGULAR COVER PLATES

MONOCHROME			
	AXOLUTE white	HA4803HD	HA4826HD
	TECH	HA4803HC	HA4826HC
	Anthracite	HA4803HS	HA4826HS
ALUMINIUM			
	brushed aluminium	HA4803XC	HA4826XC
	brushed anthracite	HA4803XS	HA4826XS
	brushed titanium	HA4803NX	HA4826NX
LAQUERED			
	white Limoges	HA4803BG	HA4826BG
ANODIZED			
	brushed chrome	HA4803CR	HA4826CR
	brushed bronze	HA4803BR	HA4826BR
	silver mat	HA4803SAN	HA4826SAN
GLASS			
	black glass	HA4803VNN	HA4826VNN
	kristall glass	HA4803VKA	HA4826VKA
	mirror glass	HA4803VSA	HA4826VSA
	white glass	HA4803VBB	HA4826VBB

SUPPORTING FRAMES

fixing with screws	H4703	H4726
luminous supporting frames (with screws) for rectangular cover plates	HA4703X	

MODULES	
3	3+3

ELLIPTIC COVER PLATES

METALLIZED			
	AXOLUTE aluminium	HB4803XC	HB4826XC
	AXOLUTE anthracite	HB4803XS	HB4826XS
LIQUID			
	liquid white	HB4803DB	HB4826DB
	liquid ivory	HB4803DA	HB4826DA
GLOSSY			
	shiny gold	HB4803OR	HB4826OR
	gold mat	HB4803OSN	HB4826OSN
STEEL			
	shiny Alessi stainl. steel	HB4803AXL	HB4826AXL
	brushed Alessi stainl. steel	HB4803AXS	HB4826AXS
WHITE			
	AXOLUTE white	HB4803HD	HB4826HD

SUPPORTING FRAMES

fixing with screws	H4703	H4726
luminous supporting frames (with screws) for elliptic cover plates	HB4703X	

CHINA STANDARD ASSEMBLY

Boxes

Supporting frames

No. of modules

Cover plates

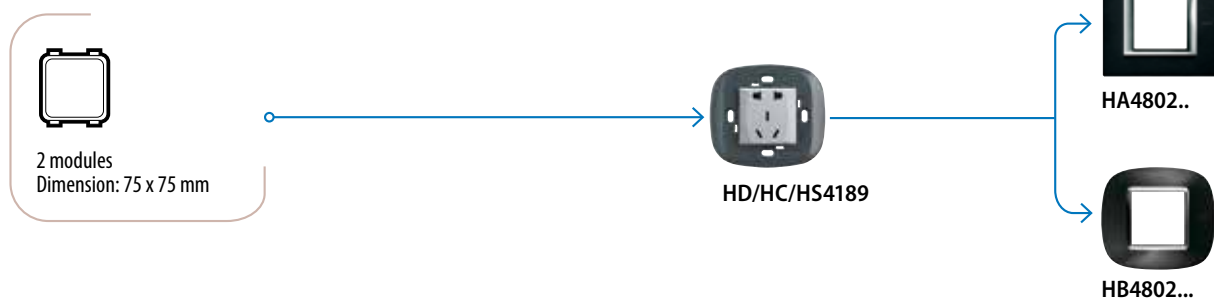
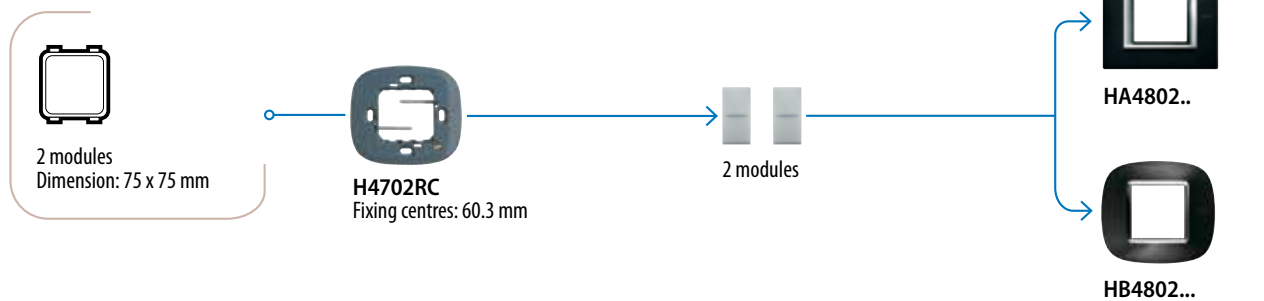















CHINA STANDARD COVER PLATES: TABLE FOR SELECTING CODES

MODULES

2







RECTANGULAR COVER PLATES

MONOCHROME		
	AXOLUTE white	HA4802HD
	Tech	HA4802HC
	Anthracite	HA4802HS
ALUMINIUM		
	brushed aluminium	HA4802XC
	brushed anthracite	HA4802XS
	brushed titanium	HA4802NX
LACQUERED		
	white Limoges	HA4802BG
ANODIZED		
	brushed chrome	HA4802CR
	brushed bronze	HA4802BR
	silver mat	HA4802SAN
GLASS		
	black glass	HA4802VNN
	kristall glass	HA4802VKA
	mirror glass	HA4802VSA
	white glass	HA4802VBB

MODULES

2

ELLIPTIC COVER PLATES

METALIZED		
	AXOLUTE aluminium	HB4802XC
	AXOLUTE anthracite	HB4802XS
LIQUID		
	liquid white	HB4802DB
	liquid ivory	HB4802DA
GLOSSY		
	shiny gold	HB4802OR
	gold mat	HB4802OSN
WHITE		
	AXOLUTE white	HB4802HD

SUPPORTING FRAMES

with screws	H4702RC	H4702RC
-------------	---------	---------

AXOLUTE AIR ASSEMBLY

Boxes

Supporting frames

No. of modules

Cover plates

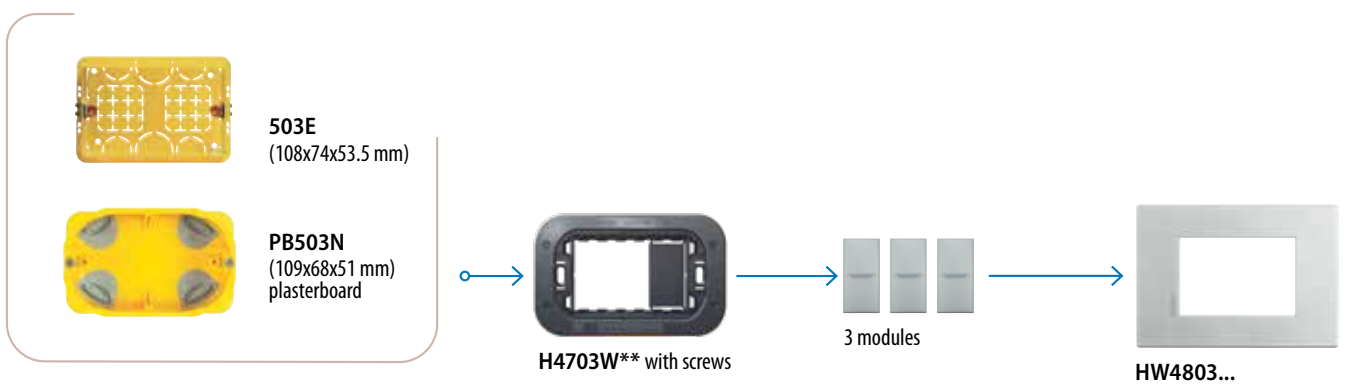
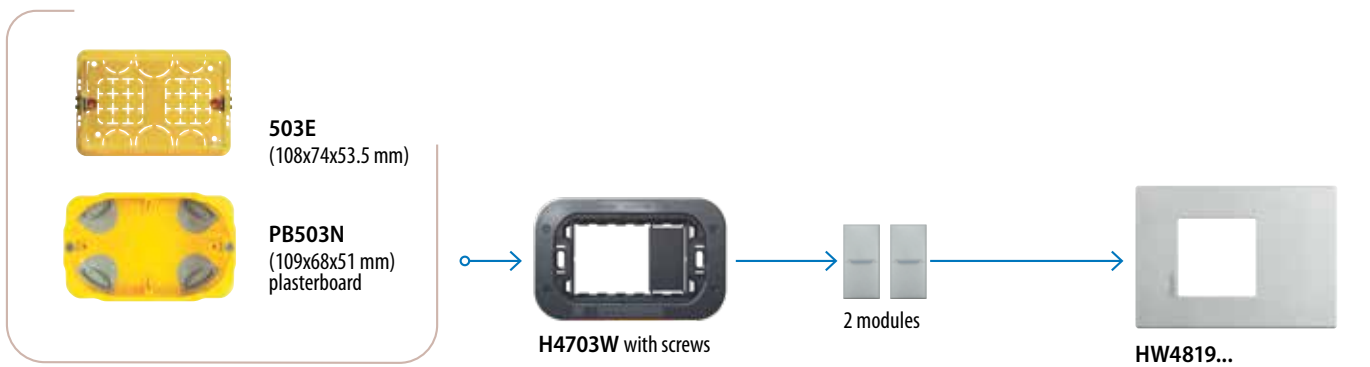

Boxes

Supporting frames

No. of modules

Cover plates

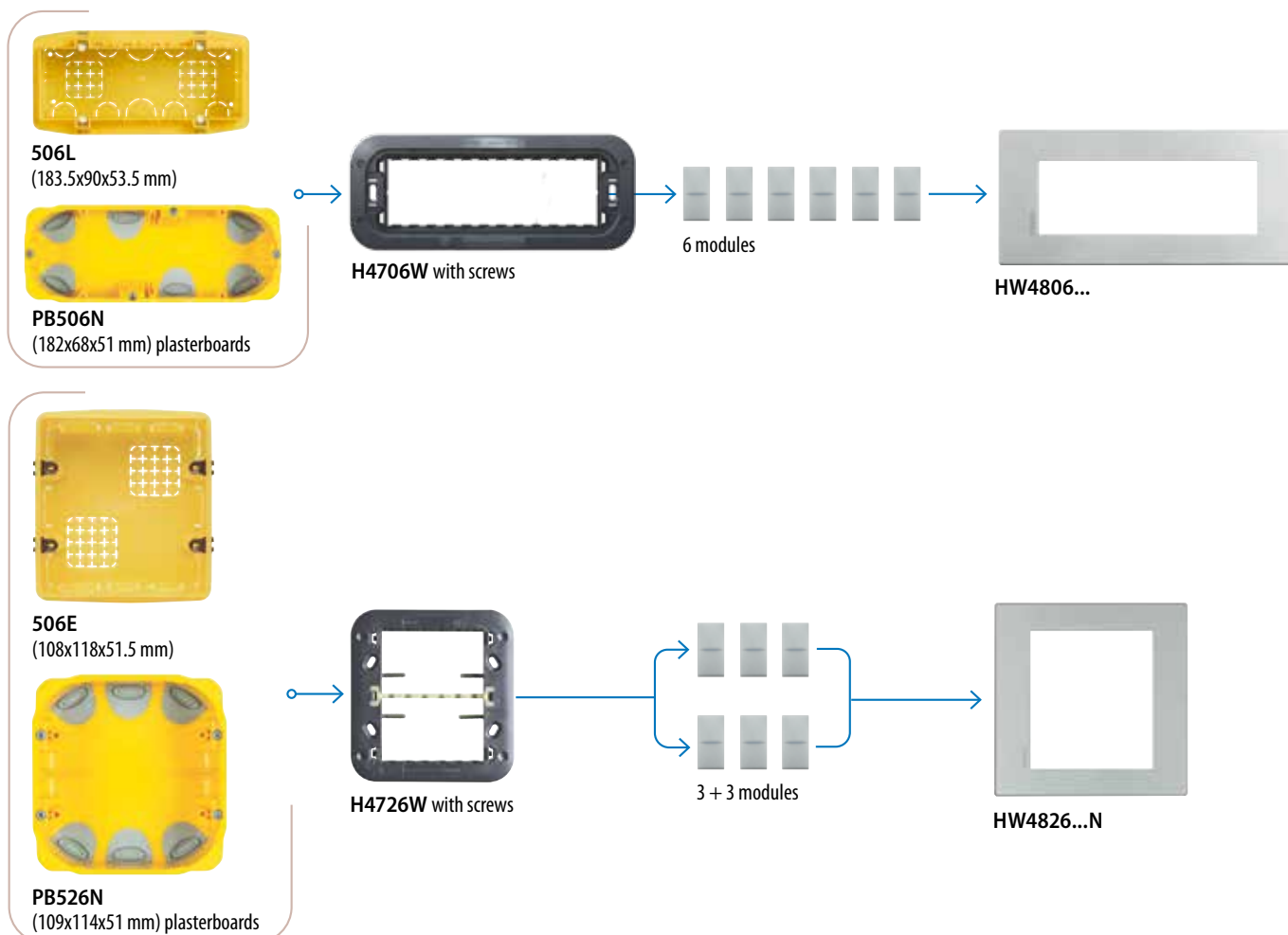

TABLE FOR SELECTING CODES

Modules

		2	3	4	6	3+3
MONOCHROME						
	White Axolute	HW4819HD	HW4803HD	HW4804HD	HW4806HD	HW4826HDN
	Tech	HW4819HC	HW4803HC	HW4804HC	HW4806HC	HW4826HCN
	Anthracite	HW4819HS	HW4803HS	HW4804HS	HW4806HS	HW4826HSN
BRUSHED						
	Brushed Titanium	HW4819CRS	HW4803CRS	HW4804CRS	HW4806CRS	HW4826CRS
	Brushed chrome	HW4819TIS	HW4803TIS	HW4804TIS	HW4806TIS	HW4826TIS
SOFT						
	Matt white	HW4819AW	HW4803AW	HW4804AW	HW4806AW	HW4826AWN
	Sand	HW4819SB	HW4803SB	HW4803SB	HW4803SB	HW4803SB
	Eclipse	HW4819XN	HW4803XN	HW4803XN	HW4803XN	HW4803XN

Supporting frames

with screws	H4703W	H4703W	H4704W	H4706W	H4726W
-------------	--------	--------	--------	--------	--------

Note: contact the BTicino sales technicians for the installation of MyHOME 3.5 screen and Videodisplay

ITALIAN STANDARD ASSEMBLY

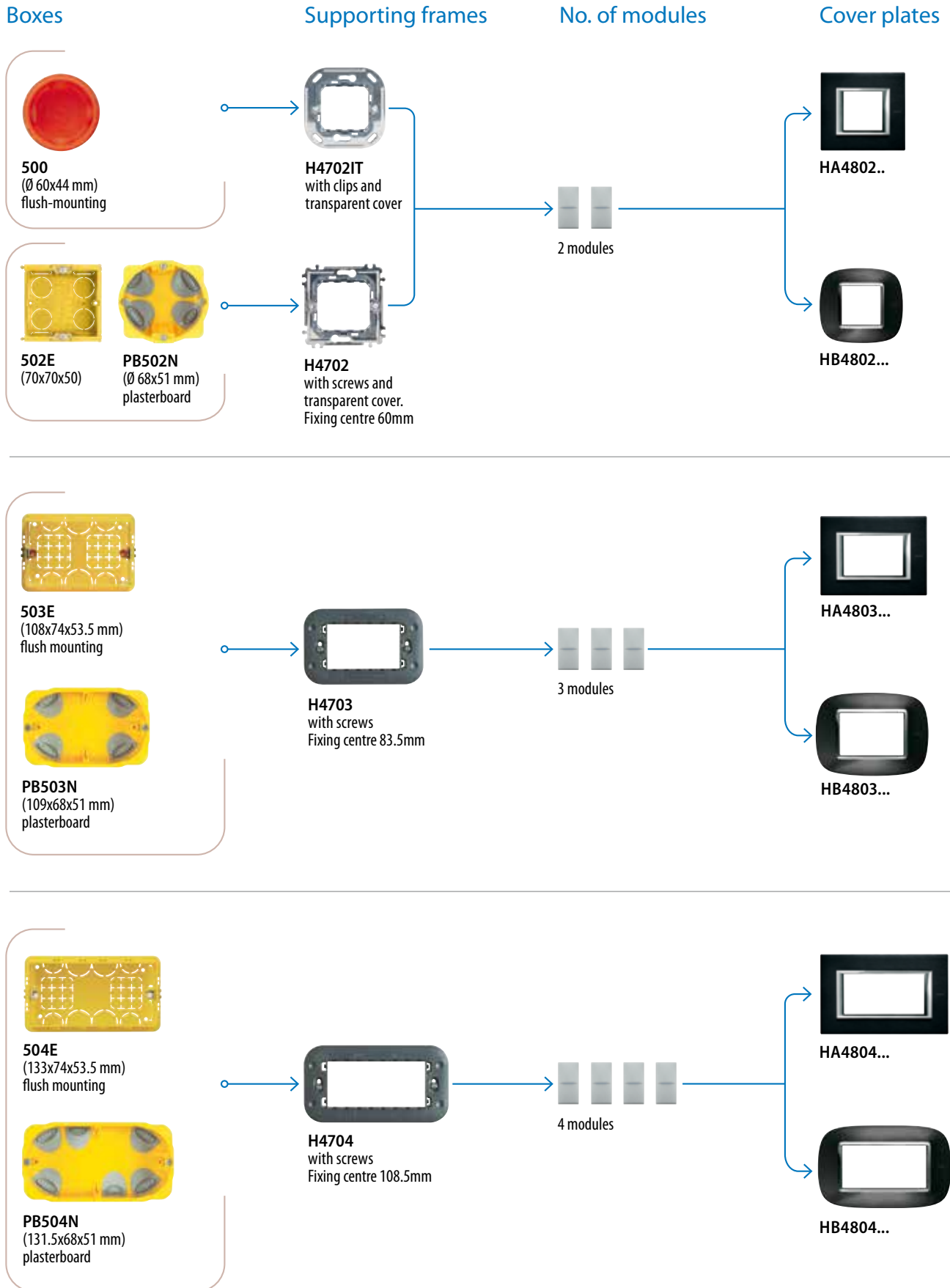

NOTE: devices available in white, tech and atrhacite colour.

Boxes

Supporting frames

No. of modules

Cover plates

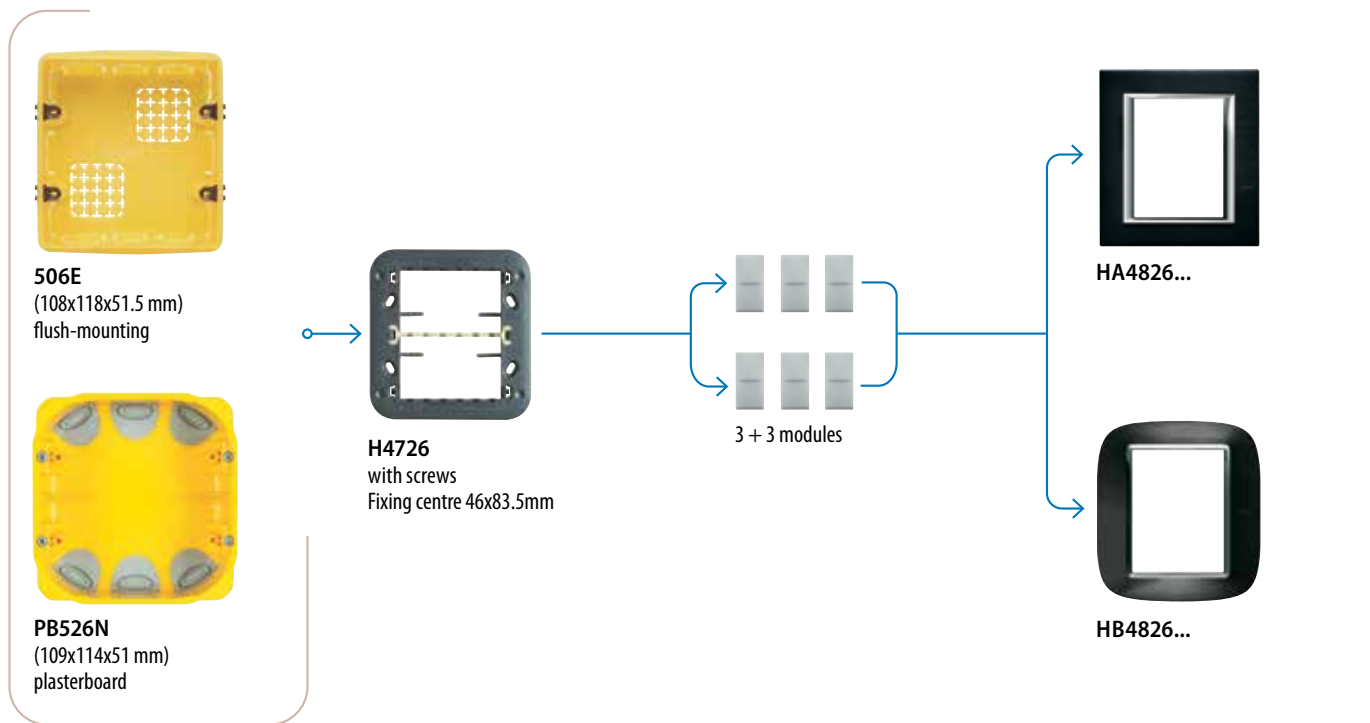
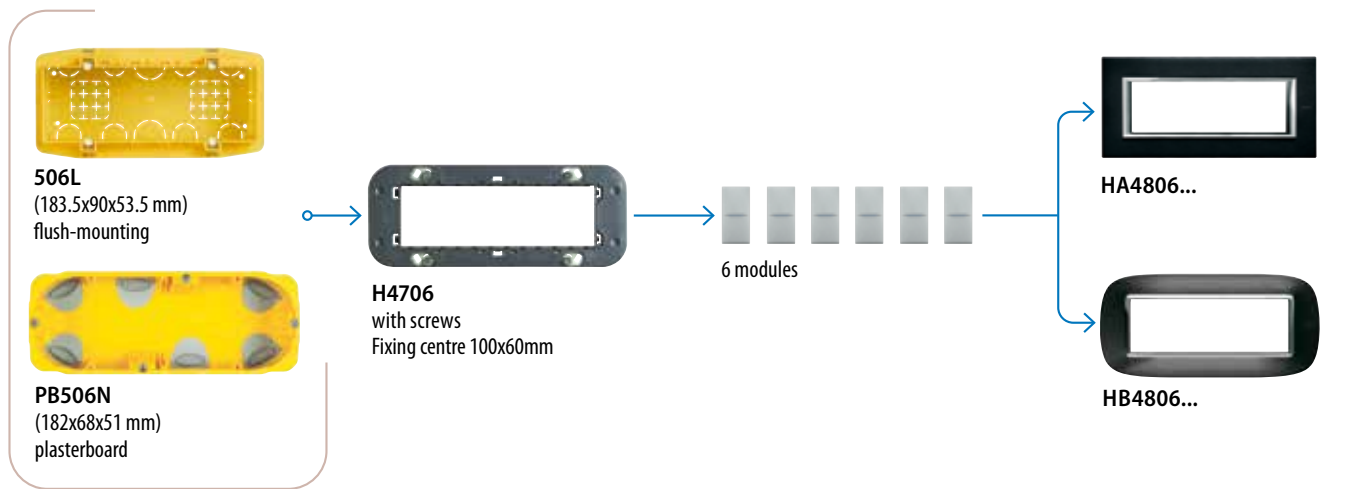















ITALIAN STANDARD RECTANGULAR COVER PLATES: TABLE FOR SELECTING CODES

MODULES

2 3 4 6 3 + 3

RECTANGULAR COVER PLATES

MONOCHROME						
	AXOLUTE white	HA4802HD	HA4803HD	HA4804HD	HA4806HD	HA4826HD
	Tech	HA4802HC	HA4803HC	HA4804HC	HA4806HC	HA4826HC
	Anthracite	HA4802HS	HA4803HS	HA4804HS	HA4806HS	HA4826HS
ALUMINIUM						
	brushed aluminium	HA4802XC	HA4803XC	HA4804XC	HA4806XC	HA4826XC
	brushed anthracite	HA4802XS	HA4803XS	HA4804XS	HA4806XS	HA4826XS
	brushed titanium	HA4802NX	HA4803NX	HA4804NX	HA4806NX	HA4826NX
LACQUERED						
	white Limoges	HA4802BG	HA4803BG	HA4804BG	HA4806BG	HA4826BG
ANODIZED						
	brushed chrome	HA4802CR	HA4803CR	HA4804CR	HA4806CR	HA4826CR
	brushed bronze	HA4802BR	HA4803BR	HA4804BR	HA4806BR	HA4826BR
	silver mat	HA4802SAN	HA4803SAN	HA4804SAN	HA4806SAN	HA4826SAN
GLASS						
	black glass	HA4802VNN	HA4803VNN	HA4804VNN	HA4806VNN	HA4826VNN
	kristall glass	HA4802VKA	HA4803VKA	HA4804VKA	HA4806VKA	HA4826VKA
	mirror glass	HA4802VSA	HA4803VSA	HA4804VSA	HA4806VSA	HA4826VSA
	white glass	HA4802VBB	HA4803VBB	HA4804VBB	HA4806VBB	HA4826VBB

SUPPORTING FRAMES

with screws		H4703	H4704	H4706	H4726
with clips	H4702IT				
luminous supporting frames (with screws) for rectangular cover plates	HA4702X	HA4703X	HA4704X		

ITALIAN STANDARD ELLIPTIC COVER PLATES: TABLE FOR SELECTING CODES

MODULES

	2	3	4	6	3+3
--	---	---	---	---	-----

ELLIPTIC COVER PLATES

METALIZED						
	AXOLUTE aluminium	HB4802XC	HB4803XC	HB4804XC	HB4806XC	HB4826XC
	AXOLUTE anthracite	HB4802XS	HB4803XS	HB4804XS	HB4806XS	HB4826XS
LIQUID						
	liquid white	HB4802DB	HB4803DB	HB4804DB	HB4806DB	HB4826DB
	liquid ivory	HB4802DA	HB4803DA	HB4804DA	HB4806DA	HB4826DA
GLOSSY						
	shiny gold	HB4802OR	HB4803OR	HB4804OR	HB4806OR	HB4826OR
	gold mat	HB4802OSN	HB4803OSN	HB4804OSN	HB4806OSN	HB4826OSN
WHITE						
	AXOLUTE white	HB4802HD	HB4803HD	HB4804HD	HB4806HD	HB4826HD

SUPPORTING FRAMES

with screws		H4703	H4704	H4706	H4726
with clips	H4702IT				
luminous supporting frames (with screws) for elliptic cover plates	HB4702X	HB4703X	HB4704X		

INDIAN STANDARD ASSEMBLY

Boxes

Supporting frames

No. of modules

Cover plates

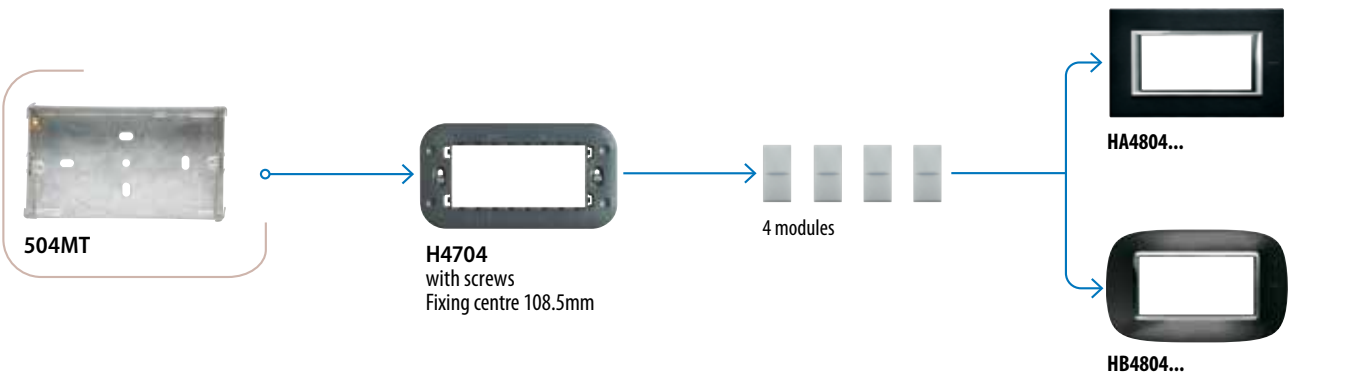
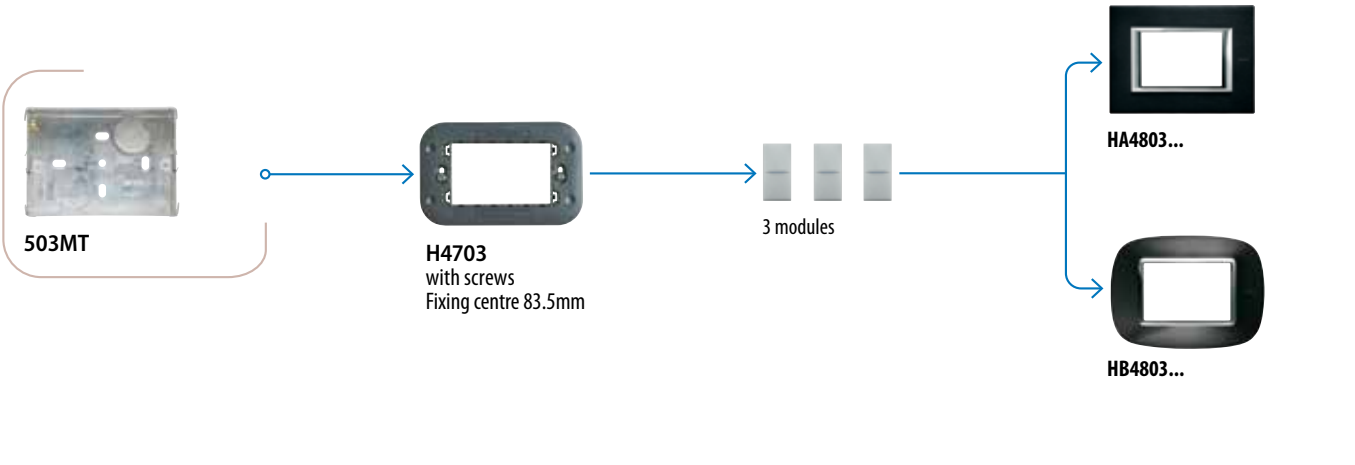
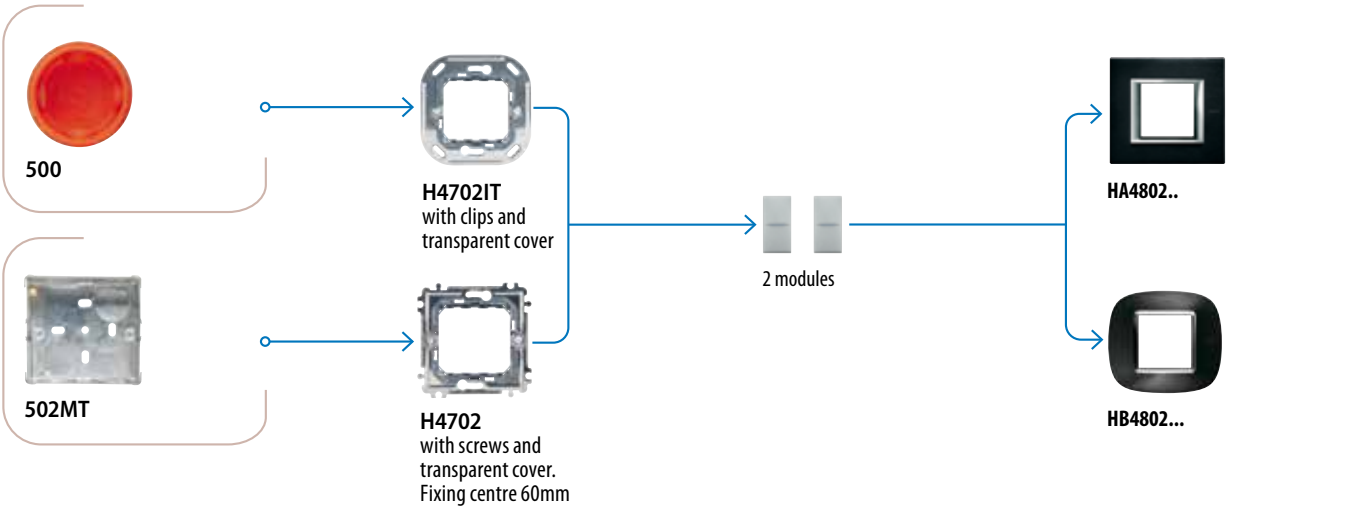

NOTE: devices available in white, tech and atracite colour.

Boxes

Supporting frames

No. of modules

Cover plates

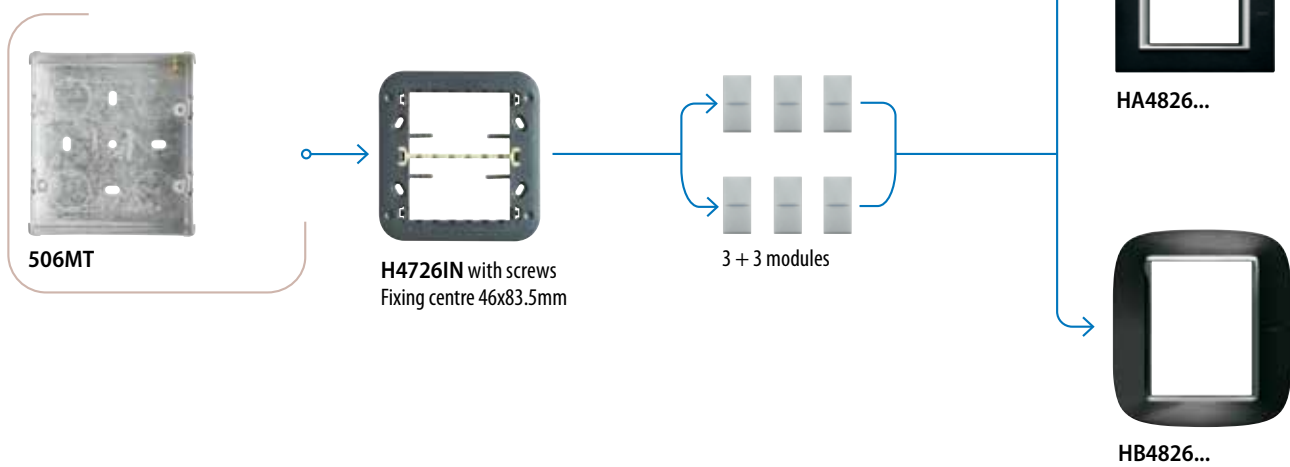
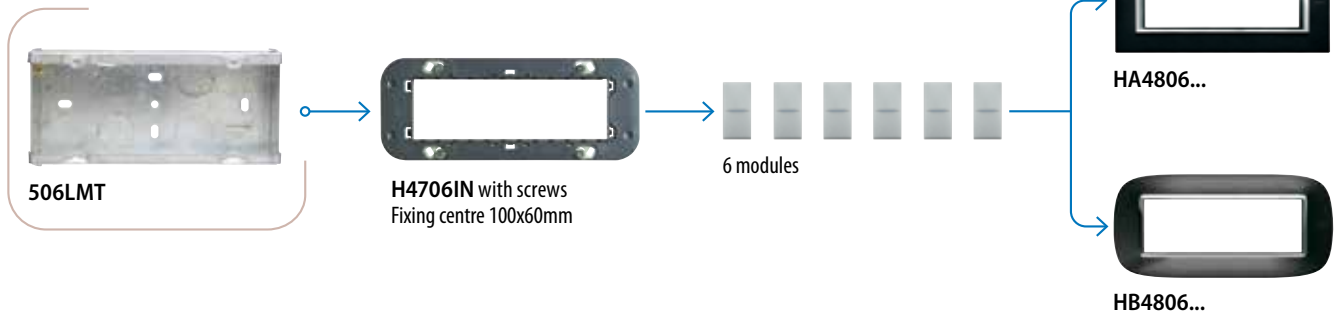



INDIAN STANDARD RECTANGULAR COVER PLATES: TABLE FOR SELECTING CODES

MODULES



2 3 4 6 3+3

RECTANGULAR COVER PLATES

MONOCHROME

	AXOLUTE white	HA4802HD	HA4803HD	HA4804HD	HA4806HD	HA4826HD
	Tech	HA4802HC	HA4803HC	HA4804HC	HA4806HC	HA4826HC
	Anthracite	HA4802HS	HA4803HS	HA4804HS	HA4806HS	HA4826HS



ALUMINIUM

	brushed aluminium	HA4802XC	HA4803XC	HA4804XC	HA4806XC	HA4826XC
	brushed anthracite	HA4802XS	HA4803XS	HA4804XS	HA4806XS	HA4826XS
	brushed titanium	HA4802NX	HA4803NX	HA4804NX	HA4806NX	HA4826NX





LACQUERED

	white Limoges	HA4802BG	HA4803BG	HA4804BG	HA4806BG	HA4826BG
---	---------------	----------	----------	----------	----------	----------

ANODIZED

	brushed chrome	HA4802CR	HA4803CR	HA4804CR	HA4806CR	HA4826CR
	brushed bronze	HA4802BR	HA4803BR	HA4804BR	HA4806BR	HA4826BR
	silver mat	HA4802SAN	HA4803SAN	HA4804SAN	HA4806SAN	HA4826SAN

GLASS

	black glass	HA4802VNN	HA4803VNN	HA4804VNN	HA4806VNN	HA4826VNN
	kristall glass	HA4802VKA	HA4803VKA	HA4804VKA	HA4806VKA	HA4826VKA
	mirror glass	HA4802VSA	HA4803VSA	HA4804VSA	HA4806VSA	HA4826VSA
	white glass	HA4802VBB	HA4803VBB	HA4804VBB	HA4806VBB	HA4826VBB

SUPPORTING FRAMES

with screws	H4702IN	H4703IN	H4704IN	H4706IN	H4726IN
luminous supporting frames (with screws) for rectangular cover plates	HA4702X	HA4703X	HA4704X		

NOTE: devices available in the following colours: white, tech, anthracite.

INDIAN STANDARD ELLIPTIC COVER PLATES: TABLE FOR SELECTING CODES

MODULES

	2	3	4	6	3+3
--	---	---	---	---	-----

ELLIPTIC COVER PLATES

METALIZED						
	AXOLUTE aluminium	HB4802XC	HB4803XC	HB4804XC	HB4806XC	HB4826XC
	AXOLUTE anthracite	HB4802XS	HB4803XS	HB4804XS	HB4806XS	HB4826XS
LIQUID						
	liquid white	HB4802DB	HB4803DB	HB4804DB	HB4806DB	HB4826DB
	liquid ivory	HB4802DA	HB4803DA	HB4804DA	HB4806DA	HB4826DA
GLOSSY						
	shiny gold	HB4802OR	HB4803OR	HB4804OR	HB4806OR	HB4826OR
	gold mat	HB4802OSN	HB4803OSN	HB4804OSN	HB4806OSN	HB4826OSN
WHITE						
	AXOLUTE white	HB4802HD	HB4803HD	HB4804HD	HB4806HD	HB4826HD

SUPPORTING FRAMES

with screws	H4702IN	H4703IN	H4704IN	H4706IN	H4726IN
luminous supporting frames (with screws) for elliptic cover plates	HB4702X	HB4703X	HB4704X		

WHICE-NIGHTER - ASSEMBLY

Boxes

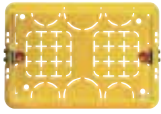

503E
(108x74x53.5 mm)
flush mounting



PB503N
(109x68x51 mm) plasterboard

Supporting frames



H4703 with screws
Fixing centre 83.5mm

No. of modules



HC4657M3 - HD4657M3



HS4657M3



504E
(133x74x53.5 mm)
flush mounting



PB504N
(131.5x68x51 mm) plasterboard



H4704 with screws
Fixing centre 108.5mm



HC4657M4 - HD4657M4

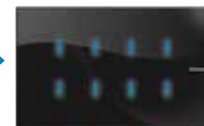

HS4657M4

AIR COVER PLATES

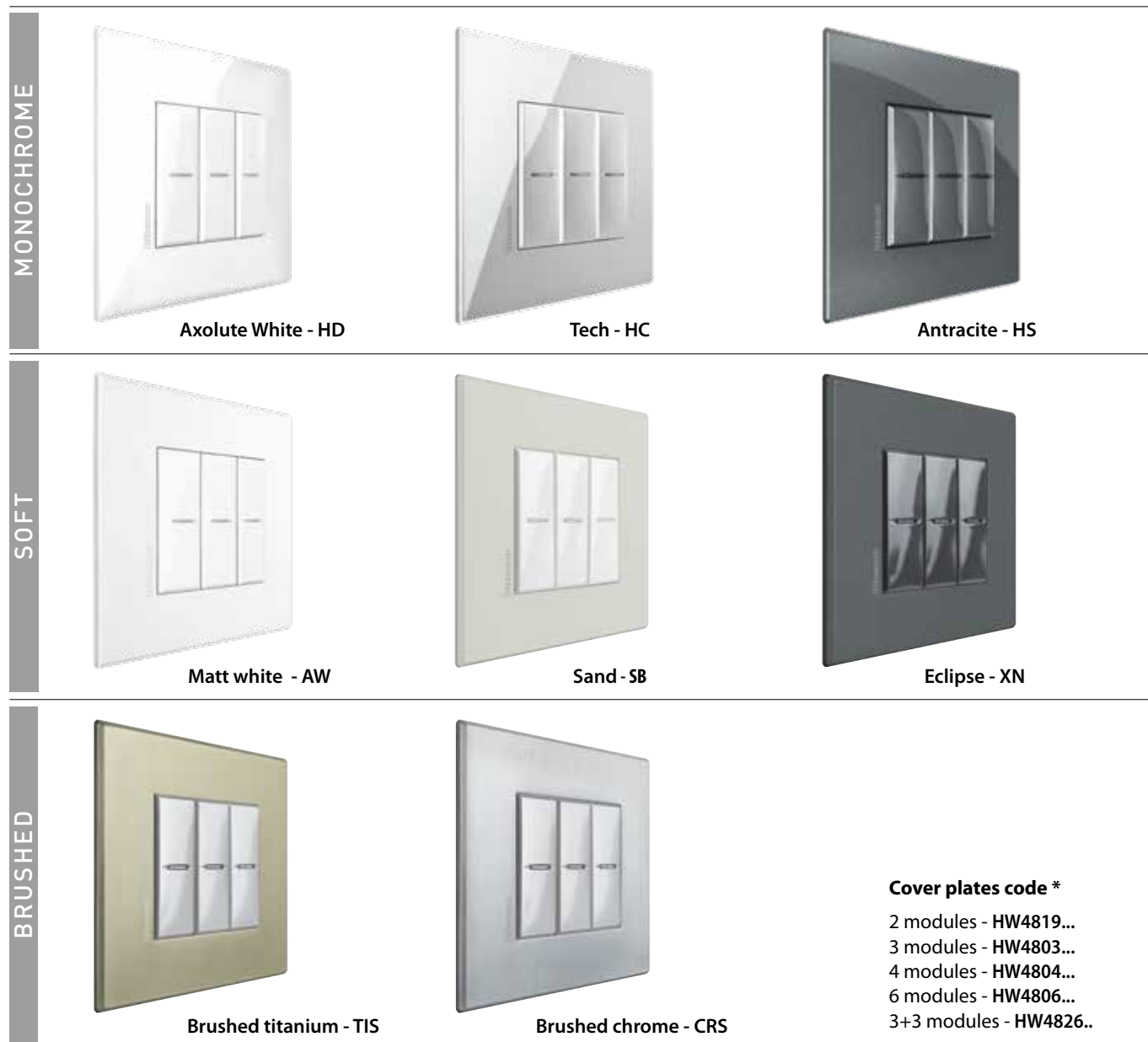

Cover plates code *
 2 modules - HW4819...
 3 modules - HW4803...
 4 modules - HW4804...
 6 modules - HW4806...
 3+3 modules - HW4826..

Matt white cover plate that can be painted



Before painting the matt white - AW cover plate



After Painting The Cover Plate

SUGGESTIONS FOR USE

The MATT WHITE cover plate can also be painted.

PAINTING

The matt white paint of the cover plates - **AW** - can be used as a primer. Before painting with house paint, the surface should be sanded/matted for better adhesion. Resin-rich products (e.g. water-based varnishes) should be used.

Notes

- Do not paint the devices (keys, sockets, etc.)
- Paint the cover plate separately and mount it when it is dry

CLEANING THE COVER PLATE

Water-based detergents should be used. Using ethyl alcohol or other solvents which could damage or soften the paint is not recommended.



Art. H4802KY

Note: Use the tool with suction cups item H4892KY to remove the installed cover plates

* see Axolute AIR assembly page for details

RECTANGULAR COVER PLATES (2 MODULES)

MONOCHROME



Finishing: AXOLUTE white - HD



Finishing: Tech - HC



Finishing: Anthracite - HS

ALUMINIUM



Finishing: Brushed aluminium - XC



Finishing: Brushed anthracite - XS



Finishing: Brushed titanium - NX

LACQUERED



Finishing: White Limoges - BG

Finishes in fine material

ANODIZED			
	Finishing: Brushed chrome - CR	Finishing: Brushed bronze - BR	Finishing: Silver - SAN
GLASS			
	Finishing: Black glass - VNN	Finishing: Kristall glass - VKA	Finishing: Mirror glass - VSA
			
	Finishing: White glass - VBB		

RECTANGULAR COVER PLATES (3 MODULES)

MONOCHROME



Finishing: AXOLUTE white - HD



Finishing: Tech - HC



Finishing: Anthracite - HS

ALUMINIUM



Finishing: Brushed aluminium - XC



Finishing: Brushed anthracite - XS



Finishing: Brushed titanium - NX

LACQUERED



Finishing: White Limoges - BG

Finishes in fine material

ANODIZED



Finishing: Brushed chrome - CR



Finishing: Brushed bronze - BR



Finishing: Silver - SAN

GLASS



Finishing: Black glass - VNN



Finishing: Kristall glass - VKA



Finishing: Mirror glass - VSA



Finishing: White glass - VBB

ELLIPTIC COVER PLATES (2 MODULES)

METALIZED



Finishing: Axolute aluminum - XC



Finishing: Axolute anthracite - XS

LIQUID



Finishing: Liquid white - DB



Finishing: Liquid ivory - DA

GLOSSY



Finishing: Shiny gold - OR



Finishing: Gold mat - OSN

WHITE



Finishing: AXOLUTE white - HD

ELLIPTIC COVER PLATES (3 MODULES)

METALIZED



Finishing: Axolute aluminum - XC

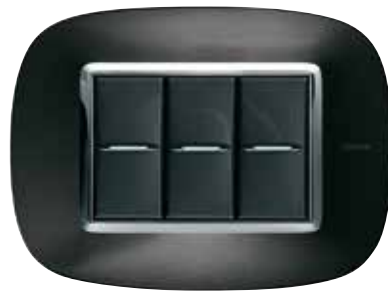

Finishing: Axolute anthracite - XS

LIQUID



Finishing: Liquid white - DB



Finishing: Liquid ivory - DA

GLOSSY



Finishing: Shiny gold - OR



Finishing: Gold mat - OSN

WHITE



Finishing: AXOLUTE white - HD

AXOLUTE

Special cover plates

Custom isations to order

The customer can request aesthetic variations of the AXOLUTE cover plates listed in our catalogue. Possible customisations:

Inner frame: the chrome inner frame can be supplied in different colours: white, aluminium and anthracite (the same as AXOLUTE mechanisms), bright or satin gold. Maximum chromatic coordination and discretion

Tampography all cover plates may be supplied with customised logos or symbols using one or more colours.

Cove plates finishes: we can supply rectangular cover plates in the typical colours of the elliptical and vice versa.

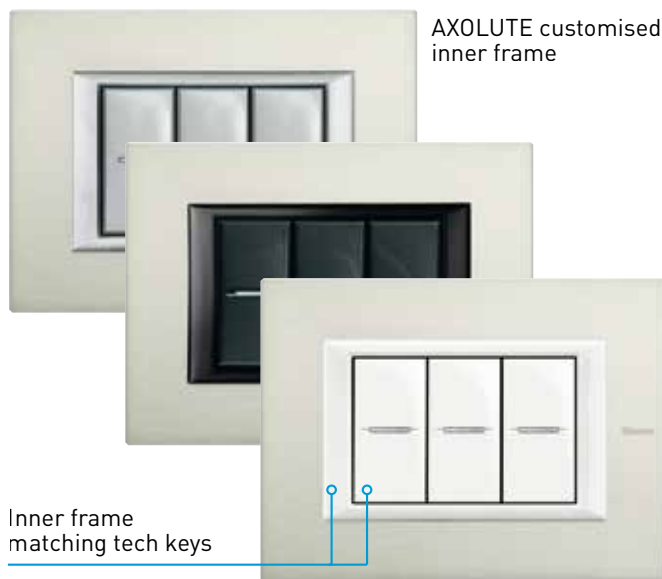

Special finishes of the switches

BTicino offers, for special project, high quality and exclusive finishes

For information or specific requirements contact your local BTicino sales representative.



Special matt titanium AXOLUTE switches